

Specifications

Model	GTH™-4018	
Measurements	Metric	Imperial
Lifting height maximum with outriggers	17.61 m	57 ft 9 in
Lifting height maximum without outriggers	17.38 m	57 ft 0 in
Lifting capacity maximum	4,000 kg	8,818 lbs
Lift capacity at maximum height	2,000 kg	4,409 lbs
Lift capacity at maximum reach	500 kg	1,102 lbs
Forward reach maximum	13.33 m	43 ft 9 in
Reach at maximum height	0.89 m	2 ft 11 in
A Height	2.44 m	8 ft
B Height at steering wheel	1.60 m	5 ft 3 in
C Width	2.42 m	7 ft 11 in
D Cab width	93 cm	3 ft
E Track	1.92 m	6 ft 4 in
F Wheelbase	2.95 m	9 ft 8 in
G Length at front wheels	4.83 m	15 ft 10 in
H Length at fork-holder plate	6.57 m	21 ft 6 in
I Ground clearance	35 cm	1 ft 2 in
J Overall width, outriggers extended	2.87 m	9 ft 5 in
L Overall length	7.77 m	25 ft 6 in
M1 Obstruction angle		40°
M2 Departure angle		46°

Productivity

Inside/outside turning radius	1.87 m/3.55 m	6 ft 2 in/11 ft 8 in
Break-out force*	6,000 kg	13,228 lbs
Drawbar pull**	6,533 kg	14,402 lbs
Drive speed max.	27 km/h	17 mph
Fork-holder plate rotation		138°
Chassis levelling on front axle		+/- 6°
Tyres (DIN 70361)	405/70 24" PR14 8 hole wheel rim	
Lifting/lowering speed**	15 sec/10 sec	
Extension/retraction speed**	23 sec/16 sec	

Power

Engine	Perkins 1104D-E44T turbo diesel 100 hp (75 kW), stage IIIA	
Transmission	Hydrostatic variable displacement pump linked to variable displacement motor. Both piston type.	
Function pumps	Boom & control system gear pump type: 280 Bar, 94 L/min. Service brake gear pump type: 250 Bar, 44 L/min.	
Fuel tank capacity	170 L	45 gal
Engine oil capacity	9.6 L	2.5 gal
Hydraulic oil tank capacity	112 L	29.6 gal

Weight*** 12,640 kg 27,865 lbs

Standards Compliance

AS 1418.19
Operating Cab conforms to ISO 3471 (ROPS) and ISO 3449 (FOPS)

Measurements

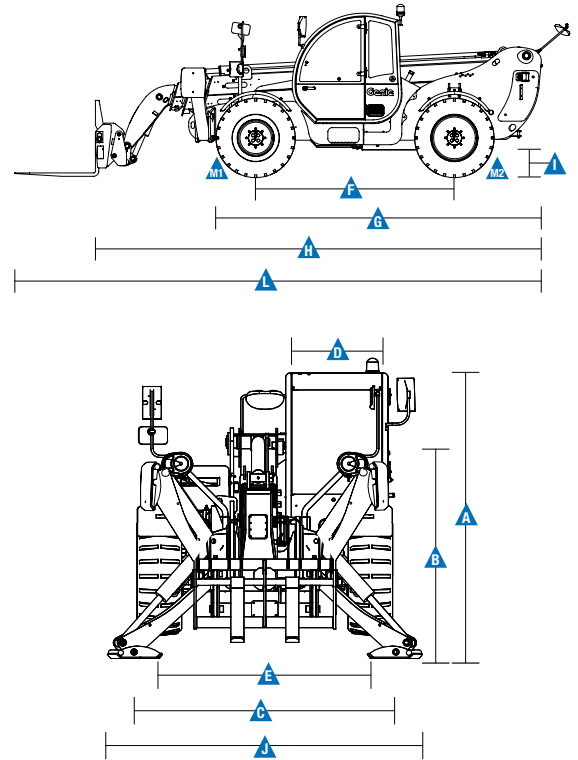

* With 800 L shovel SAE J 732/80

** Without load

*** Weight will vary depending on options and/or country standards

Load Charts

Off outriggers with 2m jib

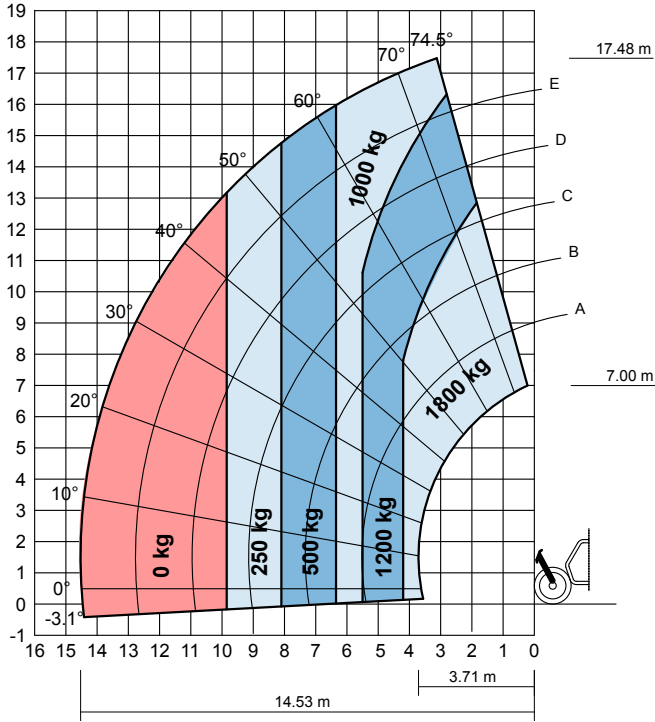

On outriggers with 2m jib

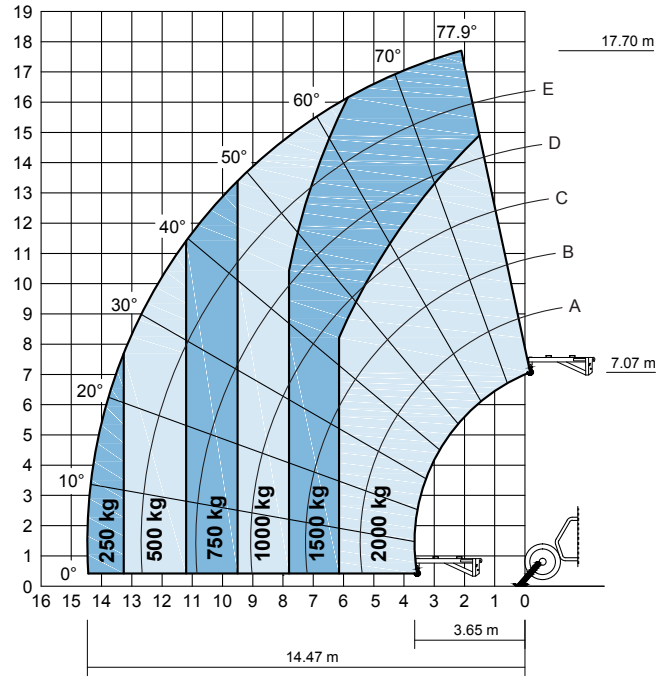

Off outriggers with side shift forks

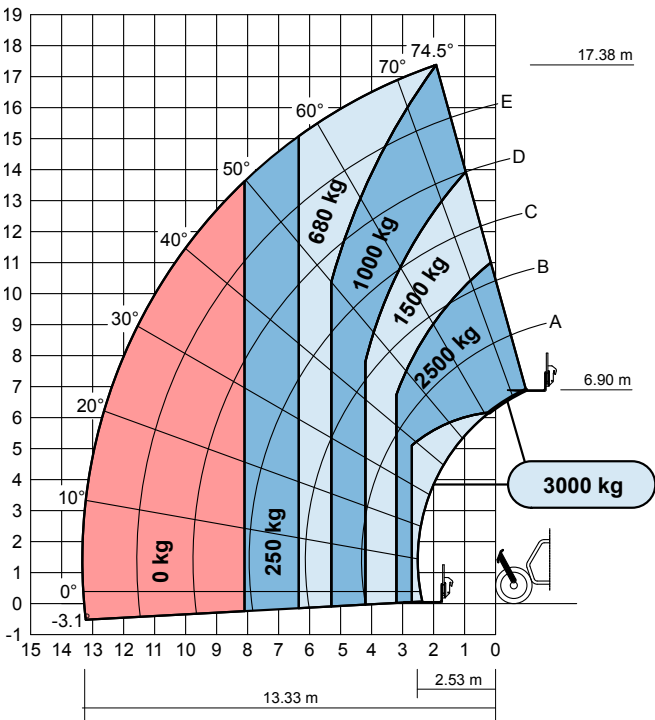

On outriggers with side shift forks

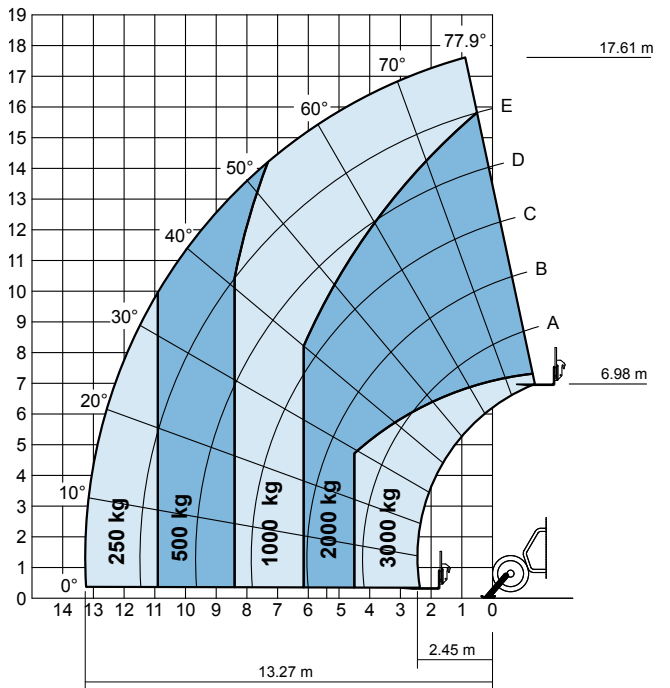

Load Charts

Off outriggers with extended forks

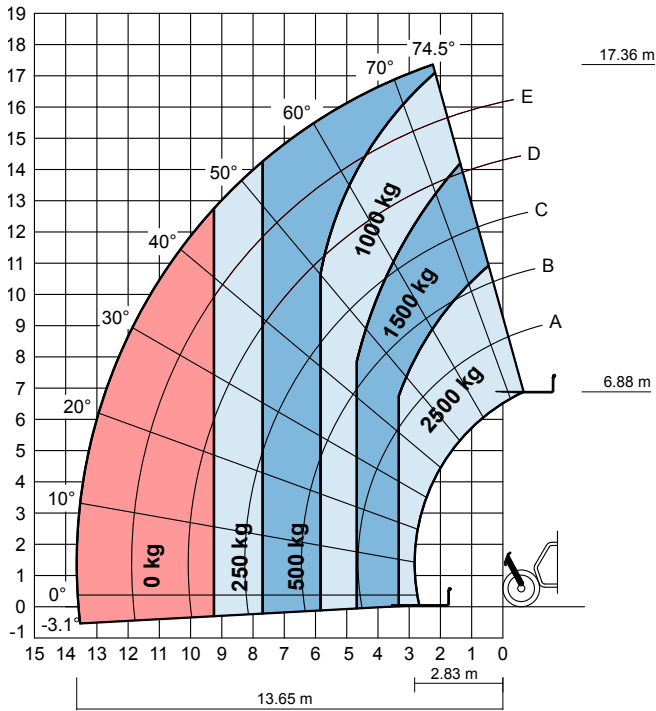

On outriggers with extended forks

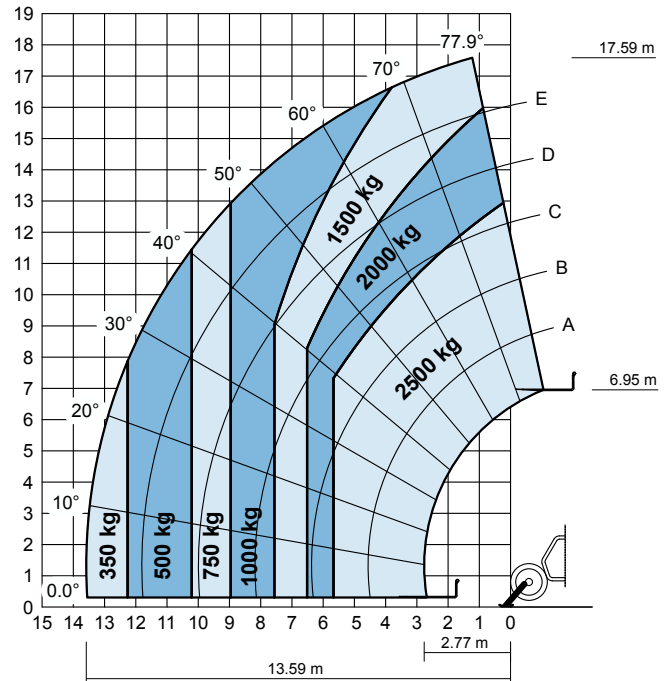

Off outriggers with fork rotator

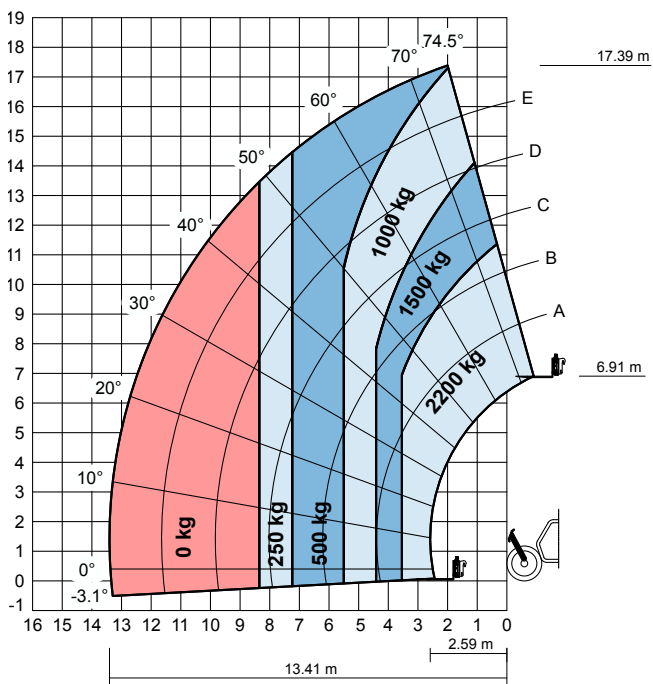

On outriggers with fork rotator

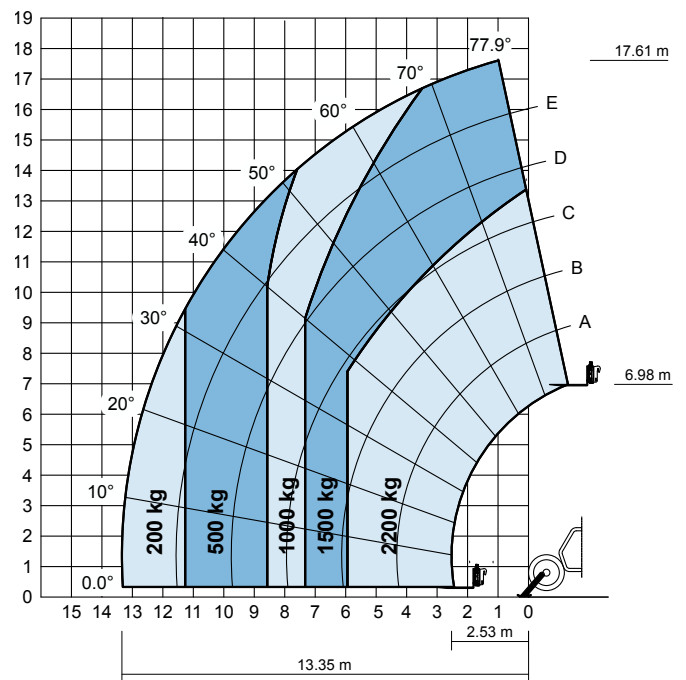

Load Charts

Off outriggers with 800 L GP bucket

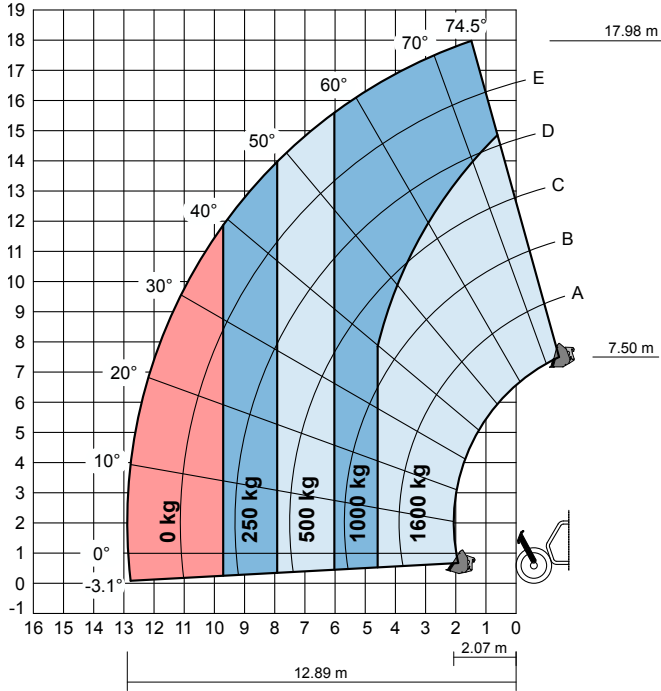

On outriggers with 800 L GP bucket

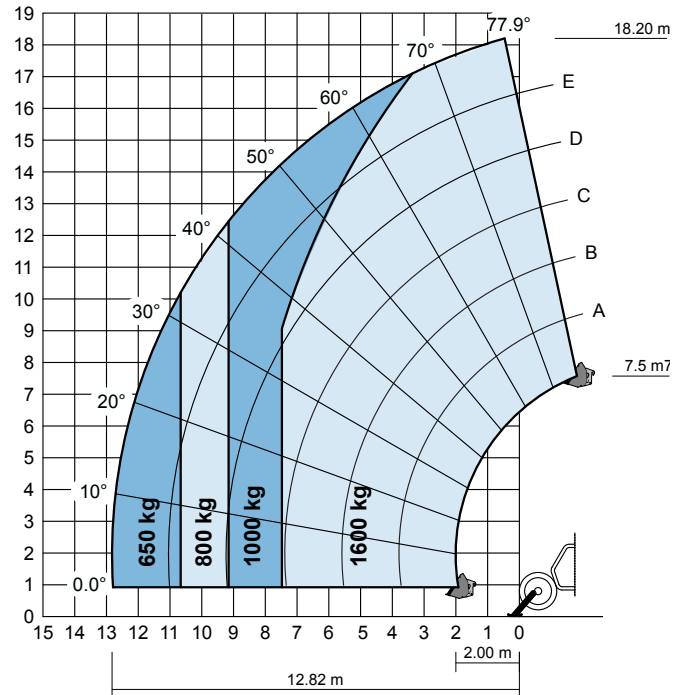

Off outriggers load chart 4-in-1 bucket 900 L

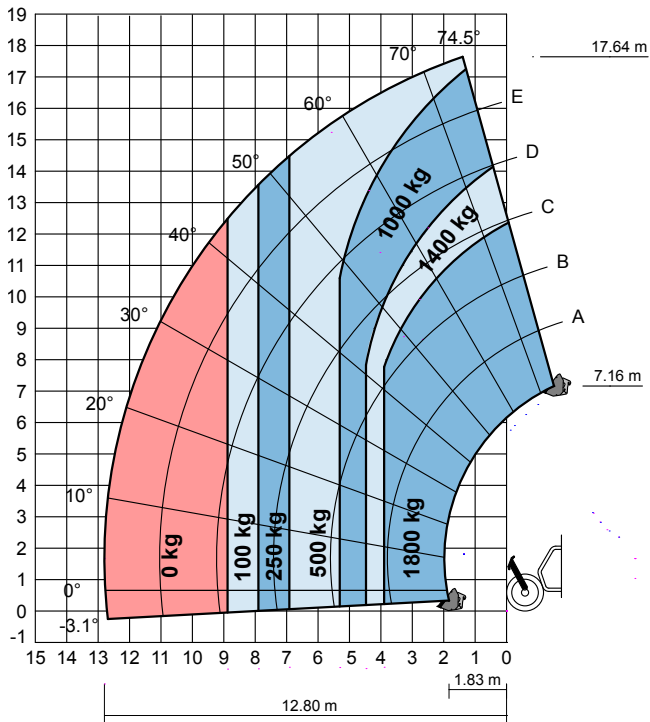

On outriggers load chart with 4-in-1 bucket 900 L

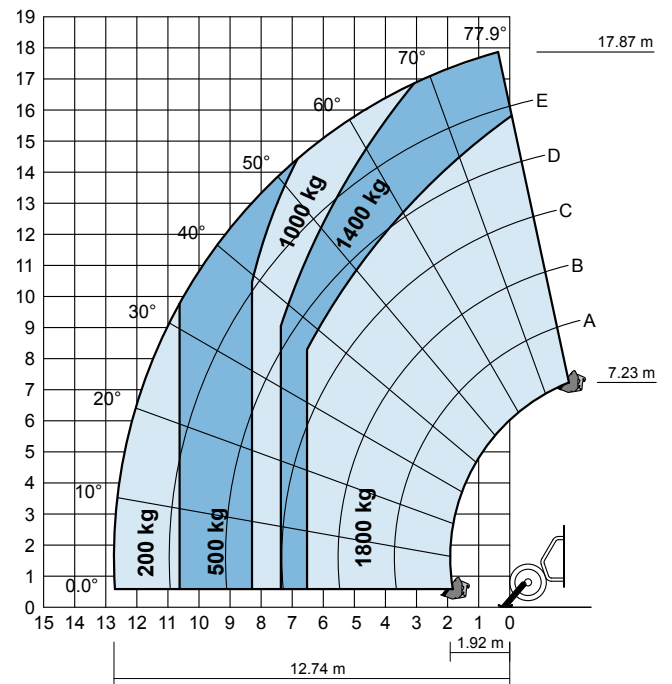

Features

Standard Features

Measurements

- 4,000 kg (8,818 lb) maximum lift capacity
- 17.61 m (57 ft 9 in) maximum lift height
- 13.33 m (43 ft 9 in) maximum forward reach

Productivity

- 4WD
- Four wheel steer
- 3 steering modes:
 - front wheel steer
 - crab steer
 - coordinated steer
- Power assisted steering
- Front outriggers
- Hydrostatic transmission with variable displacement pump
- Multifunction electroproportional 4x1 joystick
- Limited slip differential on front axle
- Two-section door (glass upper/steel lower)
- Angle and length indicators on boom correspond to load charts
- Adjustable suspended seat with operator detection seat contact switch
- Battery disconnection switch
- Large diameter steering wheel
- Front & rear windscreen wipers
- Sunshield
- Roof protection grid
- Two side view mirrors & rear fish eye mirror
- Front & rear lights
- Side mounted engine for easy access to components
- Oil immersed, multi-disc brakes on both axles
- Lockable fuel tank
- Maintenance collar
- Rear wheel alignment system
- Road/jobsite switch
- Air conditioning
- Hydraulic line on boom

Standard Features

- Load Management System (LMS) with:
 - Dynamic colour coded load chart
 - 7" colour display
 - Reversing camera
 - Optional front camera
 - Optional iButton user access control
- Hydraulic quick coupling for attachments
- Windshield protection grid

Power

- Perkins turbo charged diesel engine 100 hp (75 kW), stage IIIA

Tyres

- 405/70-24" PR14, 8 hole wheel rim

Options & Accessories

Productivity

- Adjustable spotlight on boom and cabin
- Biodegradable hydraulic oil
- 10 t hydraulic jack + 24 mm box wrench

Attachments

- Genie has a large range of attachments available. Please contact Genie or your nearest Genie telehandler dealer.



Genie – Toll free number 1800 788 633

Brisbane

HEAD OFFICE

33 Kimberley Street
Darra QLD 4076

Sydney

74 Glendenning Road
Glendenning NSW 2761

Melbourne

133 Logis Boulevard
Dandenong Sth VIC 3175

Adelaide

16-18 Nixon Road
Wingfield SA 5013

Perth

126 Sheffield Road
Welshpool WA 6106

Darwin

33 McCourt Road
Yarrowonga NT 0830

Genie USA

18340 NE 76th Street
P.O. Box 97030
Redmond, Washington
98073-9730

Distributed By:

Effective Date: June, 2015. Product specifications and prices are subject to change without notice or obligation. The photographs and/or drawings in this document are for illustrative purposes only. Refer to the appropriate Operator's Manual for instructions on the proper use of this equipment. Failure to follow the appropriate Operator's Manual when using our equipment or to otherwise act irresponsibly may result in serious injury or death. The only warranty applicable to our equipment is the standard written warranty applicable to the particular product and sale and we make no other warranty, express or implied. Products and services listed may be trademarks, service marks or trade names of Terex Corporation and/or their subsidiaries in the USA and many other countries. Genie is a registered trademark of Terex South Dakota, Inc. © 2015 Terex Corporation.